

vizulo

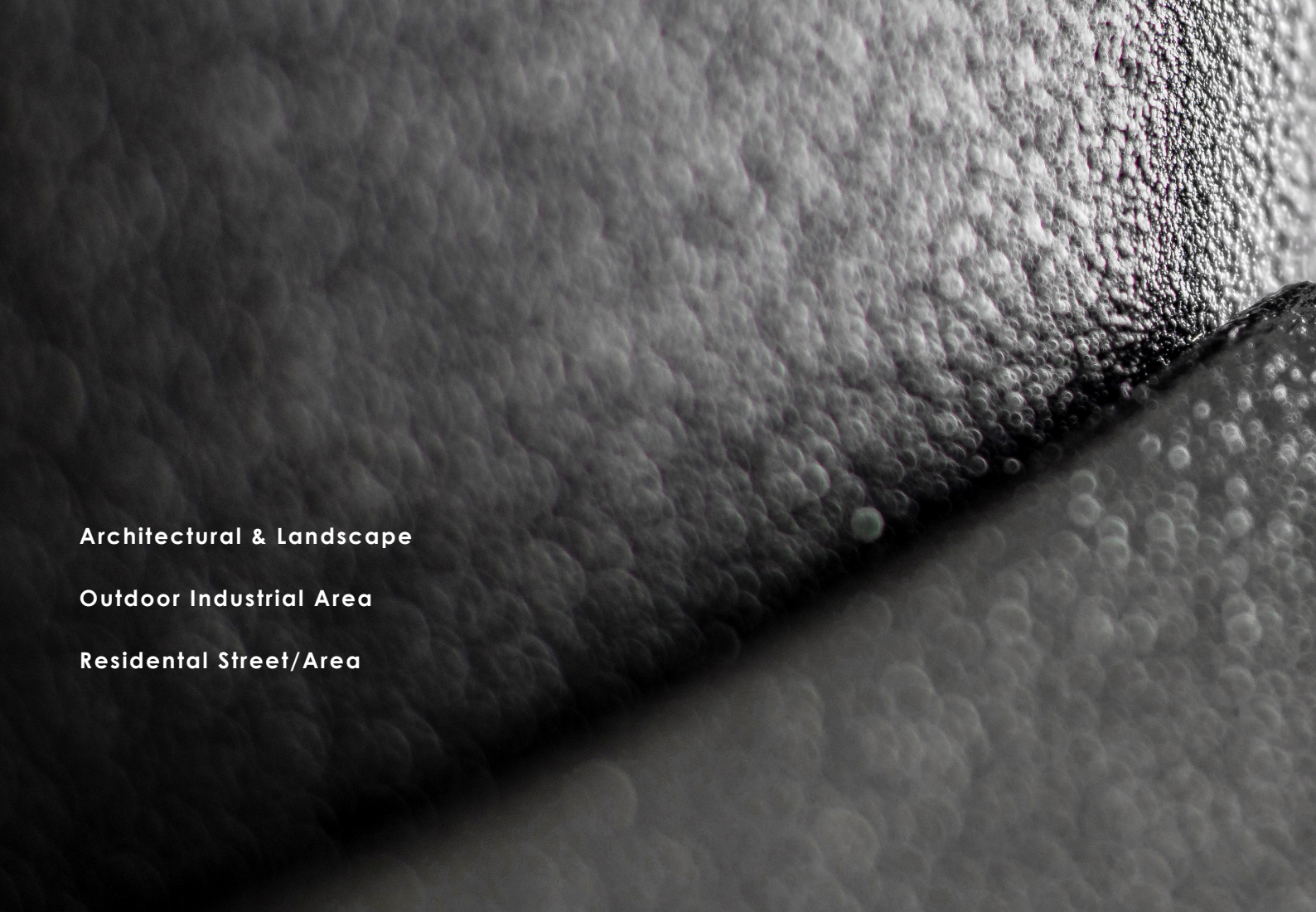

Blackbird

MICRO WITH HALO



Architectural & Landscape

Outdoor Industrial Area

Residential Street/Area

Ventilation cable gland

Combines pressure equalization and cable gland in a single unit. It ensures high air flow rates as well as high water protection capacity

Glass

Flat glass. Glass is fixed to die-cast aluminium frame with screws

LED module

High quality LED's with optimal thermal resistance and energy consumption characteristic, for high lumen output and long expected life time. Color temperature available: 2700 K, 3000 K, 4000 K
(1800 K, 2200 K, 3500 K, 5000 K, 5700 K, 6500 K available on customer request)

Protection

IP66 for the complete luminaire

Body

Die-cast aluminium

Light regulation

BLACKBIRD drivers offer integrated midnight dimming and network-controlled 1 - 10 V and DALI protocols

Impact resistance

IK08 (Vandal protected)
for the complete luminaire



Pedestrian Roads

City Centre

Midnight dimming

Midnight dimming provides multi-stage night-time power reduction based on an internal timer referenced to the power on/off time. There is no need for an external control infrastructure. The unit automatically performs a dimming profile based on the predefined scheduled reference to the midpoint, which is calculated based on the power on/off times.

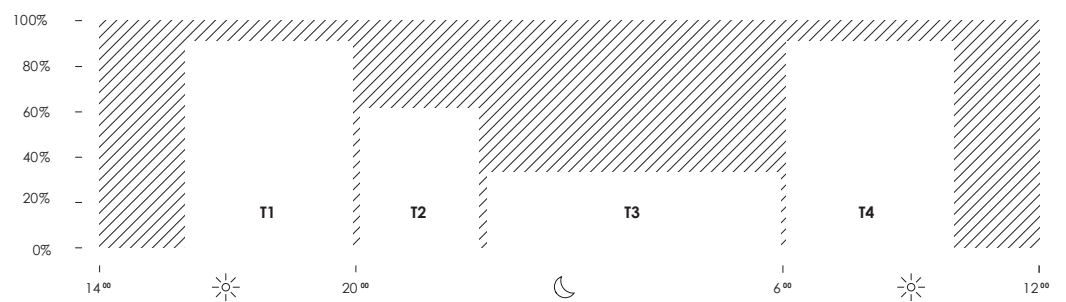

Blackbird micro with Halo



RAL7035



RAL9006



DB703



RAL9005

Other colors
available on request

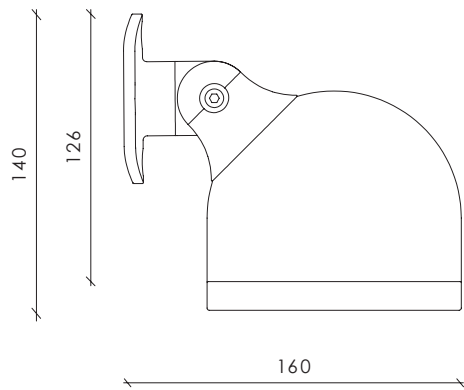

Dimensions with Halo

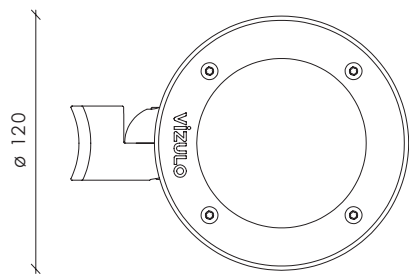

Mounting console

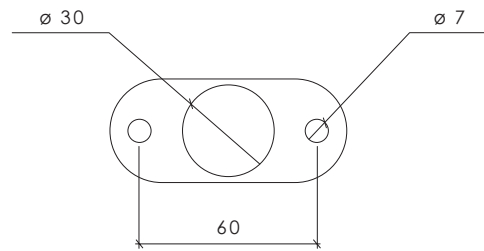

Features

BLACKBIRD MICRO Diffusion film

A semi-transparent diffuser spreads out or scatters light. Using a diffuser will control brightness and give off a soft light relative to the lamps being used.



▷ BLACKBIRD MICRO HALO with diffusion film

Technical information

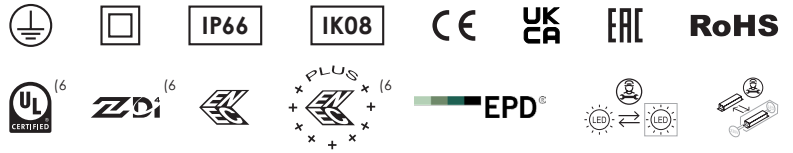

V	198 - 264 / 110 - 277 ¹⁾
Hz	50 - 60
W	5 - 12
lm	570 - 1630 ²⁾
lm/W	Up to 136
K	2700 / 3000 / 4000 ³⁾
°C	-40 to +50
CRI	>70 / >80 / >90 ³⁾

Body:	Die-cast aluminium
Dimming:	DALI / Non dimmable
Initial chromaticity:	MacAdam 5
Lifetime:	Up to 100 000 h (L98B10) at Ta = 25 °C*
Warranty:	5 years
Installation:	Pre-wired cable 30 cm ⁴⁾
Mounting:	On 76 mm pole with M6 screws
Intelligent Control:	Stand-alone / Group / CMS
Sensor:	Motion / Motion + Daylight / Daylight
Surge protection:	4 / 6 / 10 kV ⁵⁾
Corrosion protection:	Up to C5

¹⁾ Maximum operating voltage, ENEC certificate voltage 220 - 240 V, UL certificate voltage 110 - 277 V

²⁾ Lumen output indicated at CRI > 70

³⁾ 1800 / 2200 / 3500 / 5000 / 5700 / 6500 K available on request along with other not listed CRI and CCT

⁴⁾ Other lengths are on request

⁵⁾ 10 kV (L-N; L/N-PE) surge protection device available on request

⁶⁾ Coming soon

*This value is only informative and may change according to selected article. LED Lifetime is strongly depending from LEDs current and junction temperature – increase in LED current and luminaire power lead to increase of junction temperature and as consequence lifetime decrease. Thus, luminaire models with lower power, lower current (and lower junction temperature) will have higher lifetime than standard models. And high power and high current luminaire models may have negative lifetime deviation comparing to standard models. To receive precise value please contact VIZULO export representatives.

Technical parameters for final product can differ from typical data by 7% due to special conditions of LED manufacturing processes.

Model name principles

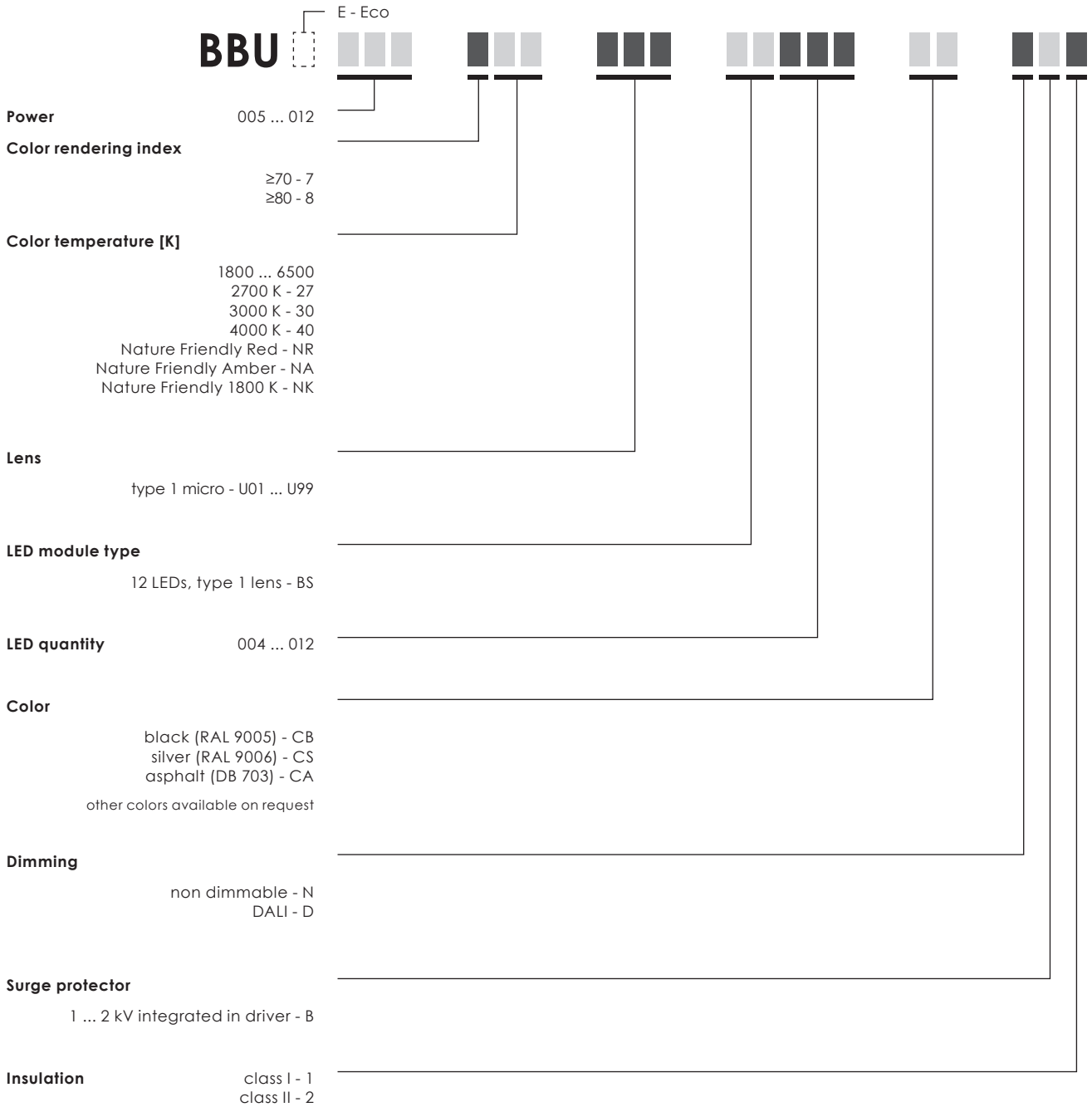

EXAMPLE BBU 010 730 U01 BS012 CB DG1

** CUSTOM CONFIGURATION EXAMPLE:
 NEMA socket + Zhaga socket; NEMA socket + Zhaga socket + midnight dimming; etc.

Custom configuration information is available in order confirmation.

LED modules

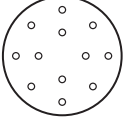
Type	Max module quantity	Min LED quantity per module	Max LED quantity per module	Max LED quantity per luminaire	LED step	LED type	Lens type	Layout
BS	1	12	12	12	-	Standard	type 1 P01...PZ9	

Cable core count

Socket	Dimming	Model number abbreviation	Input cable core count - Class I	Input cable core count - Class II
None	None	N	3	2
None	DALI	D	5	4

Accessories

Blackbird Micro diffusion film

Art. 70082009

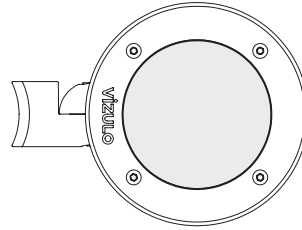

Connector

Art. 70000313

IP66 rated connector offers easy installation of the street luminaires.
3 wire cable connector

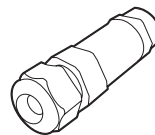

Connector

Art. 70000304

IP66 rated connector offers easy installation of the street luminaires.
5 wire cable connector

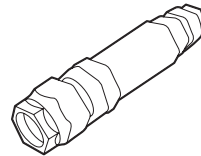

Pre-installed cable sets

For internal power supply:

3 x 1,5 mm - 0,5 m long cable.....	Art. 70000319
3 x 1,5 mm - 5 m long cable.....	Art. 70000320
3 x 1,5 mm - 6 m long cable.....	Art. 70000321
3 x 1,5 mm - 8 m long cable.....	Art. 70000322
3 x 1,5 mm - 10 m long cable.....	Art. 70000323
3 x 1,5 mm - 12 m long cable.....	Art. 70000324
3 x 1,5 mm - 18 m long cable.....	Art. 70000325
3 x 1,5 mm - 20 m long cable.....	Art. 70000425
3 x 1,5 mm - 22 m long cable.....	Art. 70000426
3 x 1,5 mm - 25 m long cable.....	Art. 70000427
3 x 1,5 mm - 32 m long cable.....	Art. 70000430
3 x 1,5 mm - 42 m long cable.....	Art. 70000431
3 x 1,5 mm - 50 m long cable.....	Art. 70000432

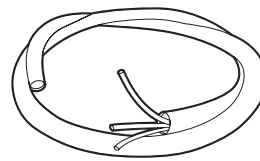

Pre-installed cable sets

For internal power supply:

5 x 1,5 mm - 0,5 m long cable.....	Art. 70000305
5 x 1,5 mm - 5 m long cable.....	Art. 70000316
5 x 1,5 mm - 6 m long cable.....	Art. 70000317
5 x 1,5 mm - 8 m long cable.....	Art. 70000318
5 x 1,5 mm - 10 m long cable.....	Art. 70000306
5 x 1,5 mm - 12 m long cable.....	Art. 70000307
5 x 1,5 mm - 18 m long cable.....	Art. 70000308
5 x 1,5 mm - 20 m long cable.....	Art. 70000428
5 x 1,5 mm - 22 m long cable.....	Art. 70000429
5 x 1,5 mm - 25 m long cable.....	Art. 70000429
5 x 1,5 mm - 32 m long cable.....	Art. 70000433
5 x 1,5 mm - 42 m long cable.....	Art. 70000434
5 x 1,5 mm - 50 m long cable.....	Art. 70000435

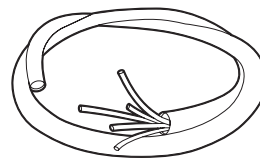

Certification



CE – conformity with European Union's health, safety and environmental protection standards

The CE mark is placed on products to state conformity with the relevant EU health, safety and environmental protection standards. In case of electronic products, the standards are, for example, the Restriction of Hazardous Substances in Electrical and Electronic Equipment (RoHS) directive, Waste Electrical and Electronic Equipment (WEEE) directive, the Electromagnetic Compatibility (EMC) directive etc. The mark ensures that the product can be sold anywhere in the European Economic Area (EEA).



UKCA - conformity with the relevant essential requirements of Great Britain

UKCA is a product mark intended to demonstrate compliance with the directives set by Great Britain (England, Scotland and Wales). It is analogous to the European Union's CE marking, meaning that depending on the type of product the applicable regulations are different. In case of LED lighting, the relevant requirements are compliance with the Electromagnetic Compatibility Regulations, the Electrical Equipment (Safety) Regulations, the Restriction of the Use of Certain Hazardous Substances in Electrical and Electronic Equipment Regulations and the Ecodesign for Energy-Related Products and Energy Information (Lighting Products) Regulations.



EAC - compliance with the regulations of the Eurasian Customs Union

The EAC Mark demonstrates conformity with all technical regulations defined by the Eurasian Customs Union. The conformity is assessed by an accredited independent testing laboratory. The EAC marking is a requirement in order to place a product on the market of Russia and the Eurasian Economic Union.

RoHS

RoHS – compliance with European Union's RoHS directive

The RoHS (Restriction of Hazardous Substances in Electrical and Electronic Equipment) directive restricts (with exceptions) the use of ten hazardous materials in the manufacture of various types of electronic and electrical equipment. The aim of the directive is to prevent the risks posed to human health and the environment related to the management of electronic and electrical waste.



* Coming soon

UL - compliance with UL standards for LED lighting

UL stands for Underwriter Laboratories, a third-party certification company that's been around for over a century. UL sets industry-wide standards for products and performs testing according to these standards to ensure that the products marked with the UL mark are safe and high quality.



* Coming soon

Zhaga-D4i - compliance with the requirements of Zhaga Book 18 or 20 and DALI standard

The Zhaga-D4i Mark represents the fact that a product is certified following the Zhaga-D4i joint certification program – a program established by Zhaga and the DALI Alliance (DiiA). The Zhaga part of the Mark represents that a product meets the requirements of Zhaga Book 18 or 20 – Zhaga standards that describe a smart interface between outdoor luminaires and sensing/ communication nodes. The DALI Alliance part of the Mark signifies that the product conforms with the DALI standard for intelligent, IoT-ready luminaires.



ENEC - compliance with European standards for electrical equipment

The ENEC Mark is the high quality European Mark for electrical equipment. It is governed by the European Testing Inspection Certification System which ensures that the testing of products is conducted at ENEC – accredited laboratories, following additional requirements regarding the testing procedures. The ENEC Mark means that the testing procedure was followed scrupulously and that the consumer can be certain of the product's safety and quality.



* Coming soon

ENEC+ - compliance with European standards for LED – based electronic products

The ENEC+ Mark is the high quality European Mark for LED – based electronic products. It demonstrates the product's compliance with the IEC standards for performance of LED modules and LED based luminaires. The ENEC+ Mark can only be granted to a product that has already acquired the ENEC Mark.



International EPD System – Environmental Product Declaration available

An Environmental Product Declaration (EPD) is a declaration of the materials, energy, transportation and other resources involved in the production, use and end-of life of a specific product. It is based on a Life Cycle Assessment (LCA) study that complies with standards EN ISO 14040 and EN ISO 14044. A product's EPD can help evaluate its impact on the environment and make sustainable choices.

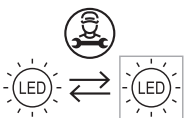

LED module replaceable by a professional

This pictogram shows that the LED modules included in the luminaire are only replaceable by a professional. This labeling is a requirement following the introduction of European Union's Regulation on energy labelling for light sources (EU) 2019/2015.

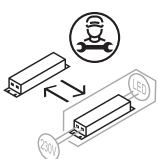

LED driver replaceable by a professional

This pictogram shows that the LED driver included in the luminaire is only replaceable by a professional. This labeling is a requirement following the introduction of European Union's Regulation on energy labelling for light sources (EU) 2019/2015.



VIZULO

Bukultu street 11
Riga, LV – 1005, Latvia

Sales: + 371 67 383 023
Production: + 371 67 383 024

office@vizulo.com
www.vizulo.com

 VIZULO

 VIZULOSOLUTIONS