

vizulo



MINI
MARTIN
Smooth



Architectural & Landscape

Outdoor Industrial Area

Residential Street/Area

Ventilation cable gland

Combines pressure equalization and cable gland in a single unit. It ensures high air flow rates as well as high water protection capacity

Glass

Flat glass. Glass is fixed to die-cast aluminium frame with screws

LED module

High quality LED's with optimal thermal resistance and energy consumption characteristic, for high lumen output and long expected life time. Color temperature available: 2700 K, 3000 K, 4000 K

(1800 K, 2200 K, 3500 K, 5000 K, 5700 K, 6500 K available on customer request)

Sockets

Zhaga and NEMA sockets compatible

Protection

IP66 for the complete luminaire

Module temperature control

The LED driver will start reducing the light output when the LED's approach critical temperature. The temperature is measured via a sensor placed on the PCB

(function available on customer request)

Body

Die-cast aluminium

Lighting protection

Built-in surge protection starting from 3 kV till 10 kV

Light regulation

MINI MARTIN drivers offer integrated midnight dimming and network-controlled 1-10 V and DALI protocols

Impact resistance

Up to IK10 (Vandal protected) for the complete luminaire



Traffic Roads

Pedestrian Roads

City Centre

Midnight dimming

Midnight dimming provides multi-stage night-time power reduction based on an internal timer referenced to the power on/off time. There is no need for an external control infrastructure. The unit automatically performs a dimming profile based on the predefined scheduled reference to the midpoint, which is calculated based on the power on/off times.

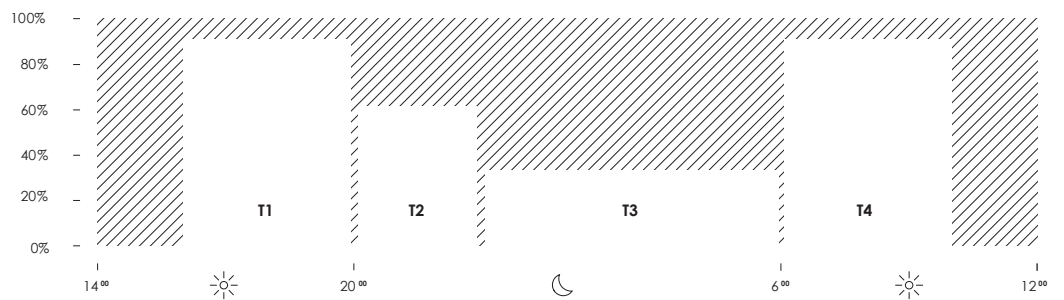

Mini martin smooth

with 60 mm console



Note! Glass with gray print is standard
(black print glass on request!)



RAL7035



RAL9006



DB703



RAL9005

Other colors
available on request

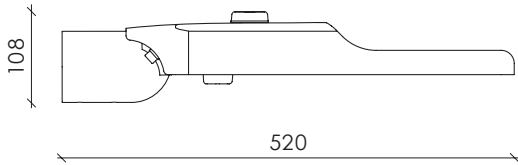
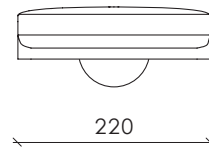
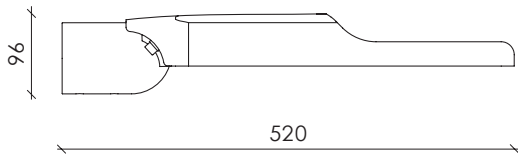

Dimensions with 2 Zhaga connectors

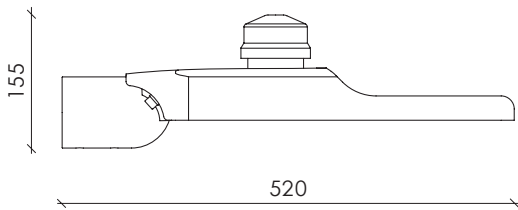

Dimensions with NEMA socket

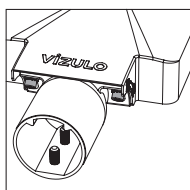
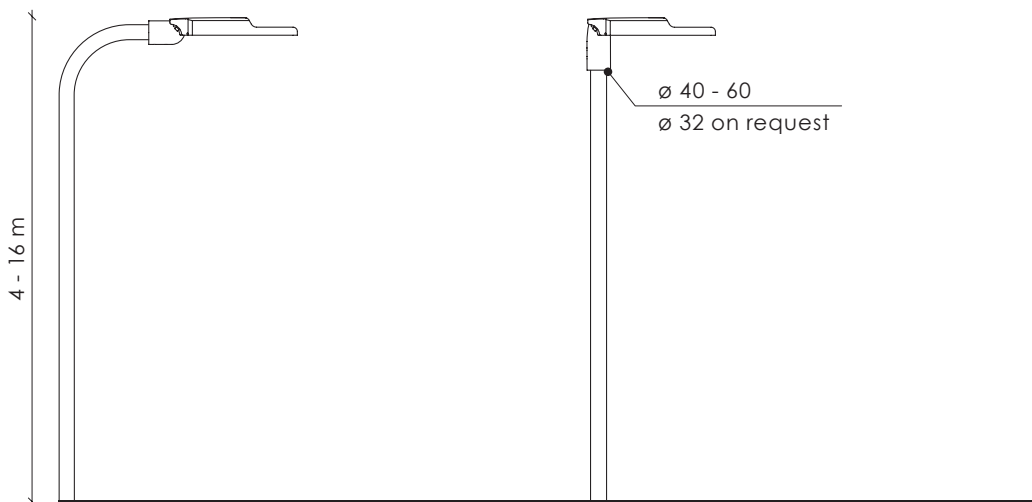

Horizontal entry $\leq -20^\circ \dots 5^\circ$

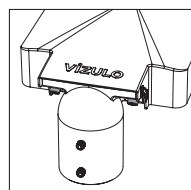
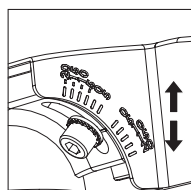

Vertical entry $\leq 0^\circ \dots 20^\circ$

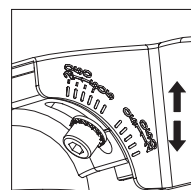

Mini martin smooth

with 60 mm adjustable console



Note! Glass with gray print is standard
(black print glass on request!)



RAL7035



RAL9006



DB703



RAL9005

Other colors
available on request

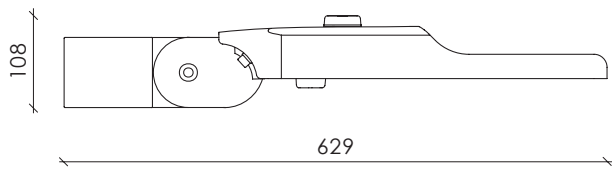
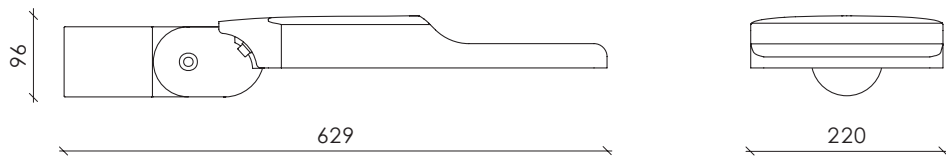

Dimensions with 2 Zhaga connectors

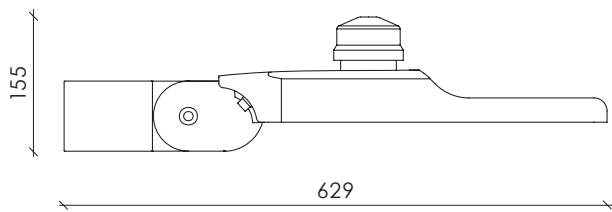

Dimensions with NEMA socket

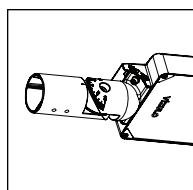
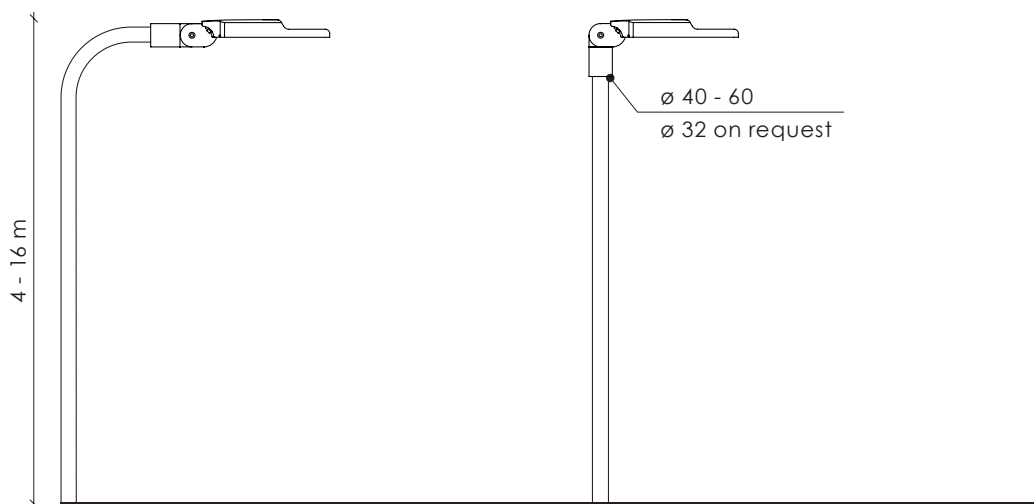

Horizontal entry $\pm 90^\circ$

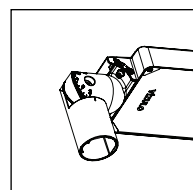
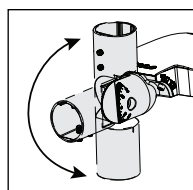

Vertical entry $\pm 90^\circ$

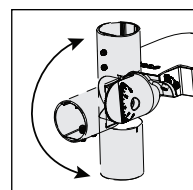

Mini martin smooth

with 76 mm adjustable console

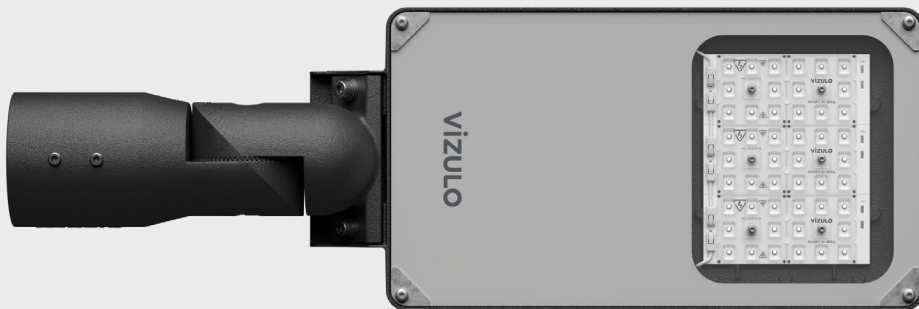

Note! Glass with gray print is standard
(black print glass on request!)



RAL7035



RAL9006



DB703



RAL9005

Other colors
available on request

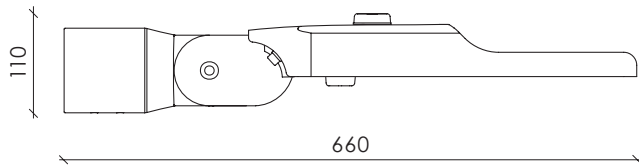
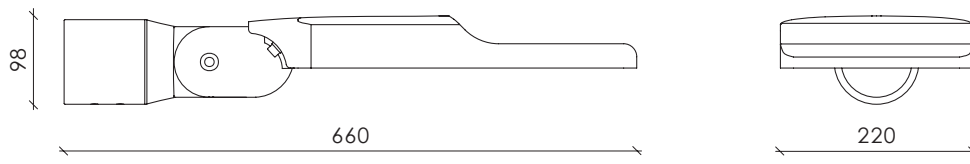

Dimensions with 2 Zhaga connectors

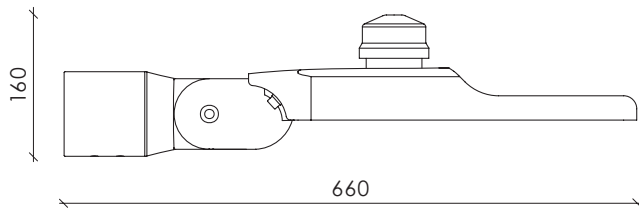

Dimensions with NEMA socket

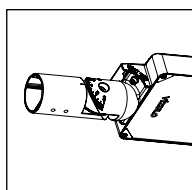
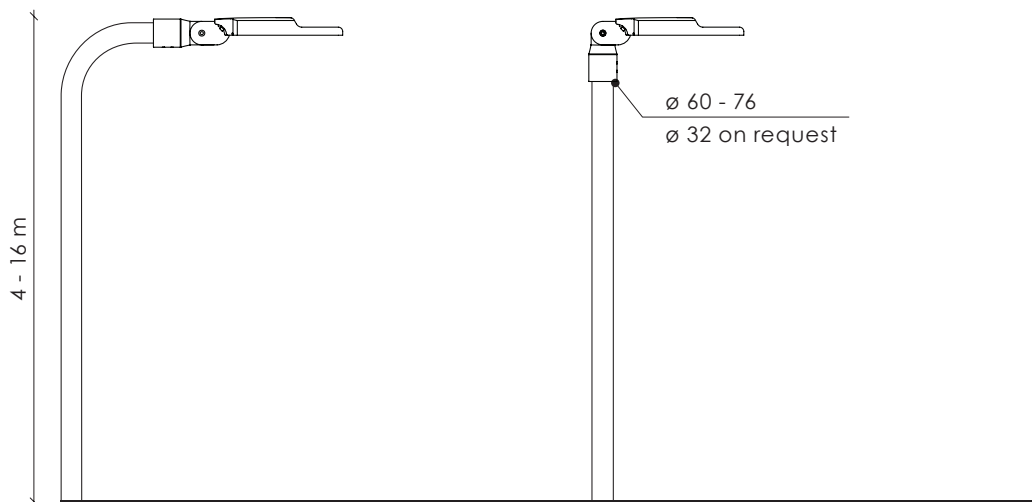

Horizontal entry $\pm 90^\circ$

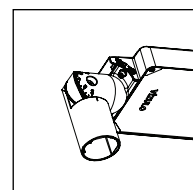
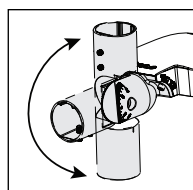

Vertical entry $\pm 90^\circ$

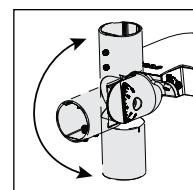

Features

▾ SAFETY SWITCH

Safety first!
Quick and safe maintenance of
the opened luminaire by automatic
disconnecting the mains supply

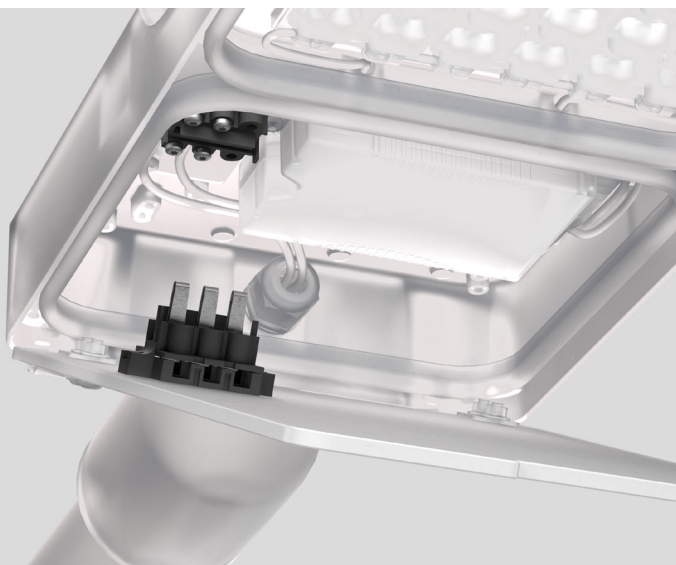

▾ ZHAGA UP AND DOWN

Connect up to 2 Zhaga
Book 18 devices!
Control luminaires and
control motion on streets!



Technical information



V	198 - 264 / 110 - 277 ⁽¹⁾
Hz	50 - 60
W	5 - 130
lm	446 - 17 480 ⁽²⁾
lm/W	90 - 187 ⁽³⁾
K	2700 / 3000 / 4000 / TW 2700 - 6500 ⁽⁴⁾
°C	-40 up to +50 ⁽⁵⁾
CRI	>70 / >80 / >90 ⁽⁴⁾

Body:	Die-cast aluminium
Dimming:	DALI / 1-10 V / Midnight dimming / Step dimming / Mains dimming
Initial chromaticity:	MacAdam 5
Lifetime:	Eco 100 000 h (L90B10) at Ta = 25 °C* Standard 100 000 h (L98B10) at Ta = 25 °C* High density 100 000 h (L98B10) at Ta = 25 °C*
Warranty:	5 years
Installation:	Pre-wired cable 30 cm ⁽⁶⁾
Spigot:	32 - 40 mm ⁽⁷⁾ / 40 - 60 mm / 60 - 76 mm
Socket:	NEMA Top / Zhaga Top and Bottom
Intelligent Control:	Stand-alone / Group / CMS
Sensor:	Motion / Motion + Daylight / Daylight
Surge protection:	4 / 6 / 10 kV ⁽⁸⁾
Corrosion protection:	Up to C5
Neto weight:	Up to 5.7 kg
Max. wind load area, SCd:	0.037 m ²

¹⁾ Maximum operating voltage, ENEC certificate voltage 198 - 264 V, UL certificate voltage 110 - 277 V

²⁾ Lumen output indicated at CRI > 70

³⁾ This value depends from configuration and can reach even higher number when max efficient components are combined

⁴⁾ 1800 / 2200 / 3500 / 5000 / 5700 / 6500 K available on request along with other not listed CRI and CCT

⁵⁾ Operating temperature differs depending on chosen output wattage

⁶⁾ Other lengths available on request

⁷⁾ Achievable with an adapter for 40 - 60 mm spigot

⁸⁾ 10 kV (L-N; L/N-PE) surge protection device available on request

⁹⁾ Depending on the configuration. Please contact VIZULO export representatives for additional information

¹⁰⁾ Coming soon

* This value is only informative and may change according to selected article. LED Lifetime is strongly depending from LEDs current and junction temperature – increase in LED current and luminaire power lead to increase of junction temperature and as consequence lifetime decrease. Thus, luminaire models with lower power, lower current (and lower junction temperature) will have higher lifetime than standard models. And high power and high current luminaire models may have negative lifetime deviation comparing to standard models. To receive precise value please contact VIZULO export representatives.

Technical parameters for final product can differ from typical data by 7% due to special conditions of LED manufacturing processes.

Standard modules

* Data for L01 optic.

Check VIZULO members section for additional information

4000 K | CRI 70

Number of LED's	4			8			12		
Nominal current, mA	270	500	730	140	540	700	280	500	670
Power, W	5	8	11	5	15	19	12	20	26
Luminous Flux, lm	520	920	1300	560	2000	2500	1650	2800	3550
Efficacy, lm/W	104	115	118	112	133	132	138	140	137
Power factor, PF	Up to 0.93			Up to 0.94			Up to 0.97		

Number of LED's	16			24		
Nominal current, mA	280	500	680	260	470	700
Power, W	15	25	35	20	35	52
Luminous Flux, lm	2150	3630	5000	3060	5300	7300
Efficacy, lm/W	143	145	143	153	151	140
Power factor, PF	Up to 0.97			Up to 0.97		

Luminaire efficacy	2700 K	5 - 52 W	446 - 6300 lm	90 - 130 lm/W
	3000 K	5 - 52 W	490 - 6900 lm	98 - 142 lm/W
	5000 K	5 - 52 W	520 - 7300 lm	104 - 153 lm/W
	5700 K	5 - 52 W	520 - 7300 lm	104 - 153 lm/W

High density modules

* Data for V01 optic.

Check VIZULO members section for additional information

4000 K | CRI 70

Number of LED's	16			32			48			
Nominal current, mA	280	480	760	290	500	760	270	680	810	880
Power, W	15	25	39	29	50	75	40	100	120	130
Luminous Flux, lm	2150	3540	5300	4600	7600	10600	6400	14120	16420	17480
Efficacy, lm/W	143	142	136	159	152	141	160	141	137	134
Power factor, PF	Up to 0.98			Up to 0.97			Up to 0.98			

Luminaire efficacy	2700 K	15 - 130 W	1850 - 14980 lm	115 - 137 lm/W
	3000 K	15 - 130 W	2000 - 16480 lm	126 - 150 lm/W
	5000 K	15 - 130 W	2150 - 17480 lm	136 - 160 lm/W
	5700 K	15 - 130 W	2150 - 17480 lm	136 - 160 lm/W

Check VIZULO members section for additional information

4000 K | CRI 70

Number of LED's	8			16			24			
Nominal current, mA	285	475	700	270	480	710	270	640	755	810
Power, W	15	25	38	28	50	75	40	100	120	130
Luminous Flux, lm	2270	3580	5050	4250	7160	9935	6352	13605	15600	16560
Efficacy, lm/W	151	143	133	152	143	132	159	136	130	127
Power factor, PF	Up to 0.98			Up to 0.98			Up to 0.99			

Luminaire efficacy	2700 K	15 - 130 W	2100 - 15415 lm	119 - 148 lm/W
	3000 K	15 - 130 W	2170 - 15850 lm	122 - 152 lm/W
	5000 K	15 - 130 W	2240 - 16400 lm	126 - 157 lm/W
	5700 K	15 - 130 W	2210 - 16170 lm	124 - 155 lm/W

Model name principles

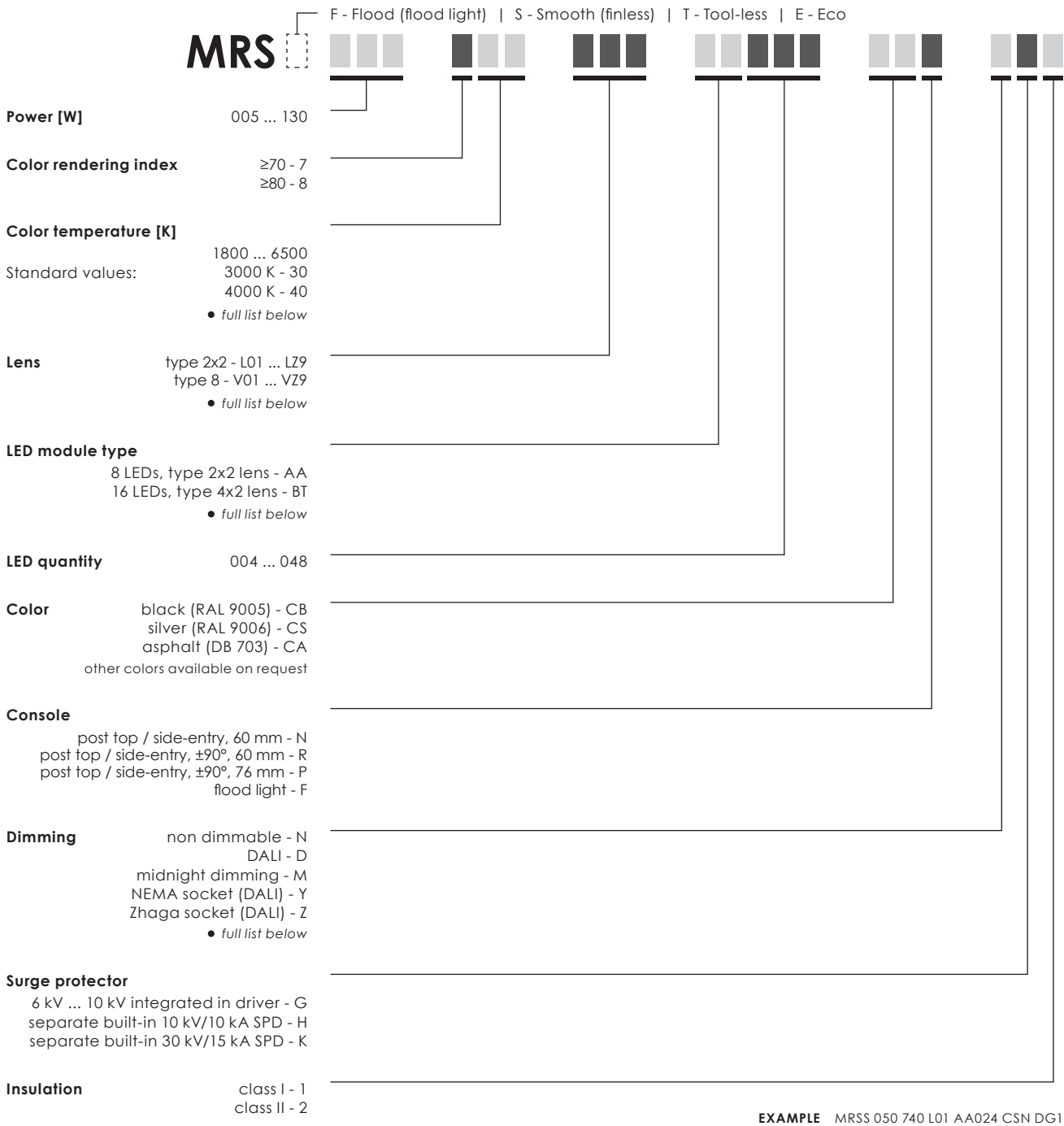

• Full list of options

Color temperature [K]

1800 ... 6500
2700 K - 27
3000 K - 30
4000 K - 40
Tunable White 2700-6500 - TW
Nature Friendly Red - NR
Nature Friendly Amber - NA
Nature Friendly 1800 K - NK

Lens

type 8 - V01 ... VZ9
type 2x2 - L01 ... LZ9
type 4x2 - B01 ... BZ9
type 6x1 - T01 ... TZ9
type 12 - Y01 ... YZ9
type 1 - Z01 ... ZZ9
custom configuration - M01 ... NZ9

Dimming

non dimmable - N
DALI - D
1-10 V - A
midnight dimming - M
midnight dimming + DALI - R
step dimming - S
mains dimming - L
wireless - W
NEMA socket (DALI) - Y
Zhaga socket (DALI) - Z
*custom configuration - X

LED module type

8 LEDs, type 2x2 lens - AA
16 LEDs, type 4x2 lens - BT
16 LEDs, type 8 lens - AF
8 LEDs, type 8 lens - BH
4 LEDs, type 2x2 lens - BG

* CUSTOM CONFIGURATION EXAMPLE

NEMA socket + Zhaga socket; NEMA socket + Zhaga socket + midnight dimming; etc.
Custom configuration information is available in order confirmation.

LED modules

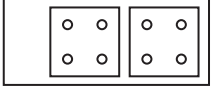
Type	Max module quantity	Min LED quantity per module	Max LED quantity per module	Max LED quantity per luminaire	LED step	LED type	Lens type	Layout
AA	3	4	8	24	2	Standard Eco	type 2x2 L01...LZ9	
AF	3	4	16	48	4	Standard	type 8 V01...VZ9	
BT	3	4	16	48	4	Standard	type 4x2 B01...BZ9	

Cable core count

Socket	Dimming	Model number abbreviation	Input cable core count - Class I	Input cable core count - Class II
None	None	N	3	2
None	DALI	D	5	4
None	Midnight dimming	M	3	2
None	Midnight dimming + DALI	R	5	4
None	Step dimming	S	5 ⁽¹⁾	4 ⁽¹⁾
None	Mains dimming	L	3	2
Zhaga	DALI	Z	3 ⁽²⁾	2 ⁽²⁾
Zhaga	Midnight dimming	X	3	2
Zhaga	Mains dimming	X	3	2
NEMA	DALI	Y	3 / 5 ⁽³⁾	2 / 4 ⁽³⁾
NEMA	Midnight dimming	X	3	2
NEMA	Step dimming	X	5 ⁽¹⁾	4 ⁽¹⁾
NEMA	Mains dimming	X	3	2

¹⁾ 1 core unused

²⁾ DALI wires used only for internal connection between driver and Zhaga socket(s)

³⁾ +2 cores for external DALI connection

Optics

Standard modules

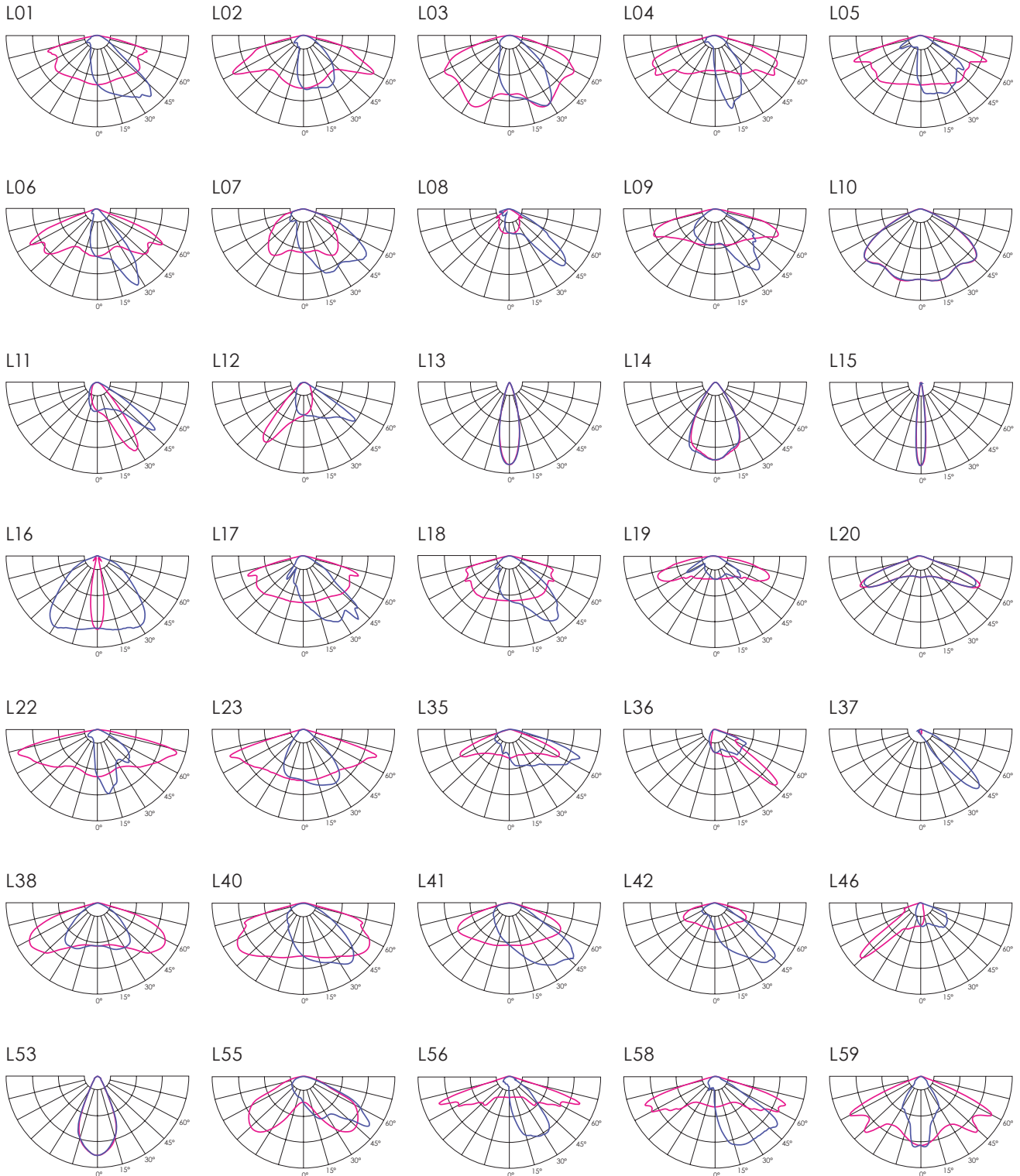

L60

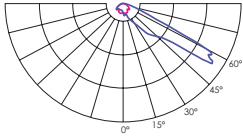

L61

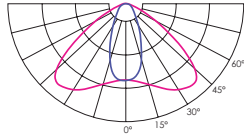

L62

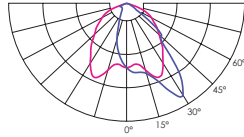

L63

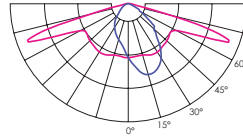

L64

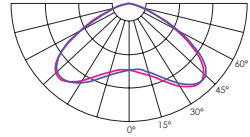

L65

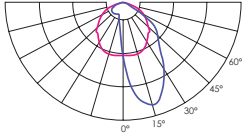

L66

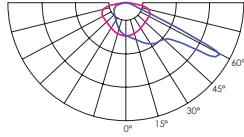

L67

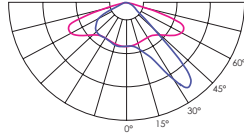

L68

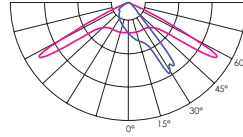

L76

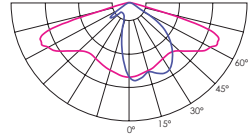

L77

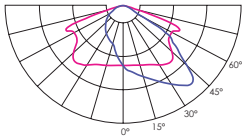

L78

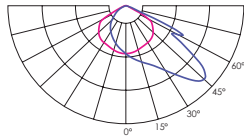

L79

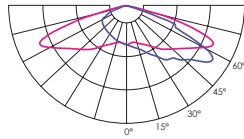

L80

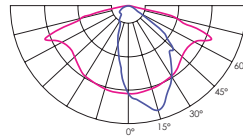

L88

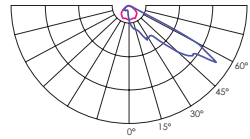

L90

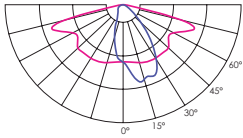

L94

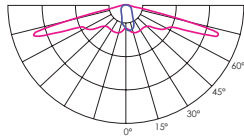

LB2

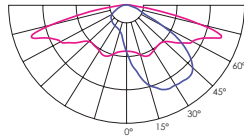

LB3

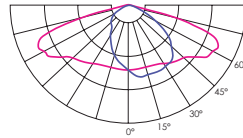

High density modules

V01

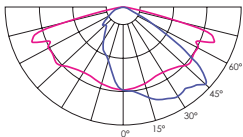

V04

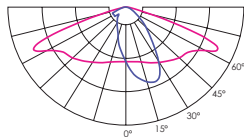

V05

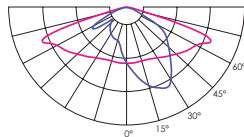

V10

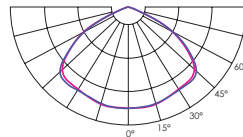

V13

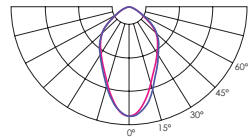

V16

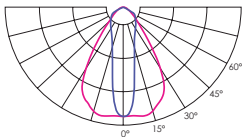

V20

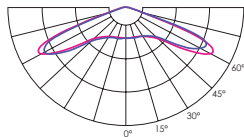

V22

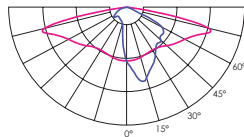

V35

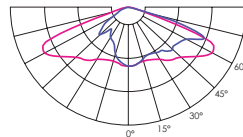

V45

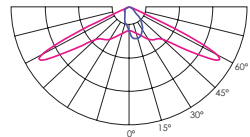

V52

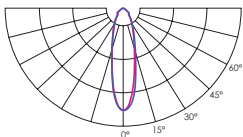

V53

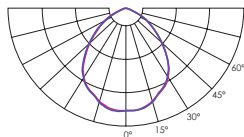

V57

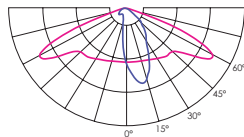



Pedestrian crossing optics



V	198 - 264 / 110 - 277 ⁽¹⁾
Hz	50 - 60
W	5 - 52 ⁽²⁾ 15 - 130 ⁽³⁾
lm	Up to 7 300 ⁽²⁾ Up to 16 560 ⁽³⁾
lm/W	Up to 187 ⁽⁴⁾
K	2700 / 3000 / 4000 / TW 2700 - 6500 ⁽⁵⁾
°C	-40 up to +50 ⁽⁶⁾
CRI	>70 / >80 / >90 ⁽⁵⁾

Body:	Die-cast aluminium
Dimming:	DALI / 1-10 V / Midnight dimming / Step dimming / Mains dimming
Initial chromaticity:	MacAdam 5
Lifetime:	Eco 100 000 h (L90B10) at Ta = 25 °C* Standard 100 000 h (L98B10) at Ta = 25 °C*
Warranty:	5 years
Installation:	Pre-wired cable 30 cm ⁽⁷⁾
Spigot:	32 - 40 mm ⁽⁸⁾ / 40 - 60 mm / 60 - 76 mm
Socket:	NEMA Top / Zhaga Top and Bottom
Intelligent Control:	Stand-alone / Group / CMS
Sensor:	Motion / Motion + Daylight / Daylight
Surge protection:	4 / 6 / 10 kV ⁽⁹⁾
Corrosion protection:	Up to C5
Neto weight:	Up to 5.7 kg
Max. wind load area, SCd:	0.037 m ²

¹⁾ Maximum operating voltage, ENEC certificate voltage 198 - 264 V, UL certificate voltage 110 - 277 V

²⁾ Standard modules, lumen output indicated at CRI > 70

³⁾ ECO modules, lumen output indicated at CRI > 70

⁴⁾ This value depends from configuration and can reach even higher number when max efficient components are combined

⁵⁾ 1800 / 2200 / 3500 / 5000 / 5700 / 6500 K available on request along with other not listed CRI and CCT

⁶⁾ Operating temperature differs depending on chosen output wattage

⁷⁾ Other lengths available on request

⁸⁾ Achievable with an adapter for 40 - 60 mm spigot

⁹⁾ 10 kV (L-N; L/N-PE) surge protection device available on request

¹⁰⁾ Depending on the configuration. Please contact VIZULO export representatives for additional information

¹¹⁾ Coming soon

* This value is only informative and may change according to selected article. LED Lifetime is strongly depending from LEDs current and junction temperature – increase in LED current and luminaire power lead to increase of junction temperature and as consequence lifetime decrease. Thus, luminaire models with lower power, lower current (and lower junction temperature) will have higher lifetime than standard models. And high power and high current luminaire models may have negative lifetime deviation comparing to standard models. To receive precise value please contact VIZULO export representatives.

Technical parameters for final product can differ from typical data by 7% due to special conditions of LED manufacturing processes.

Right side traffic

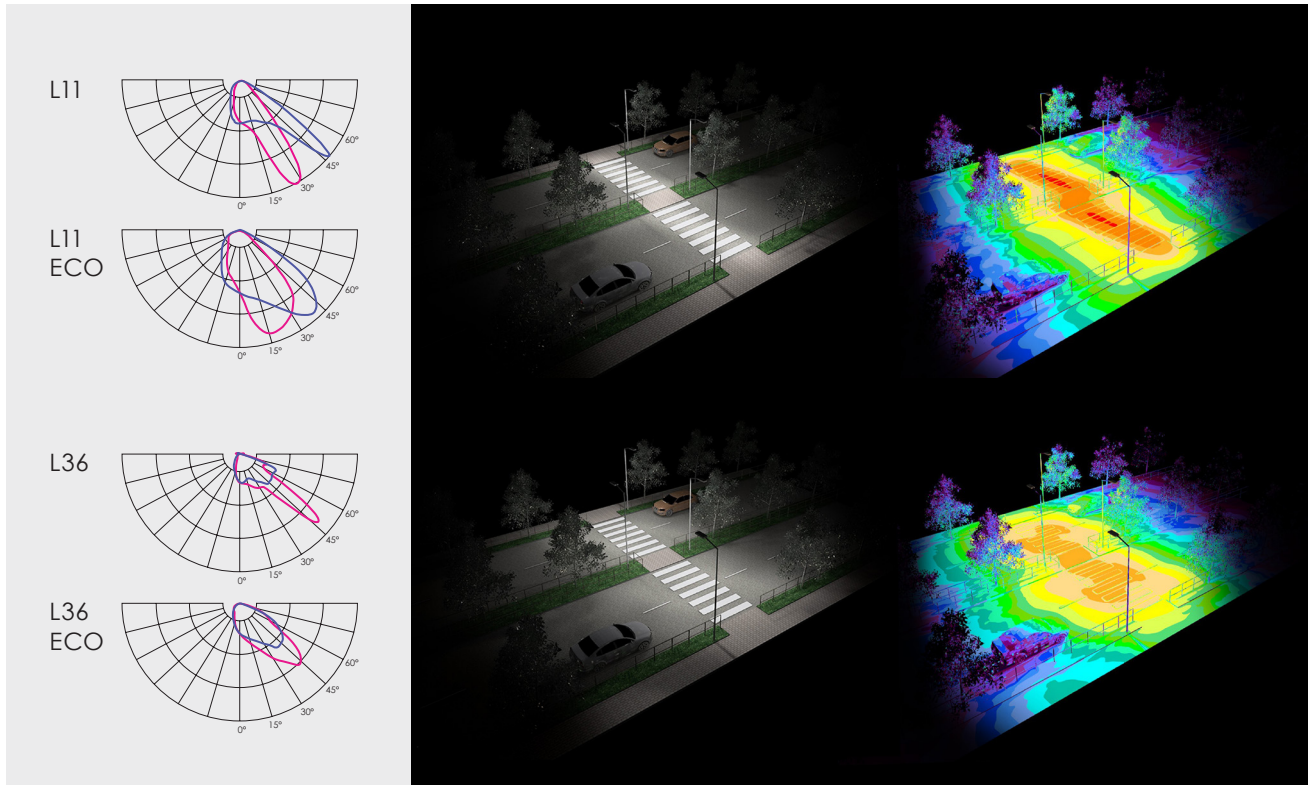

Left side traffic

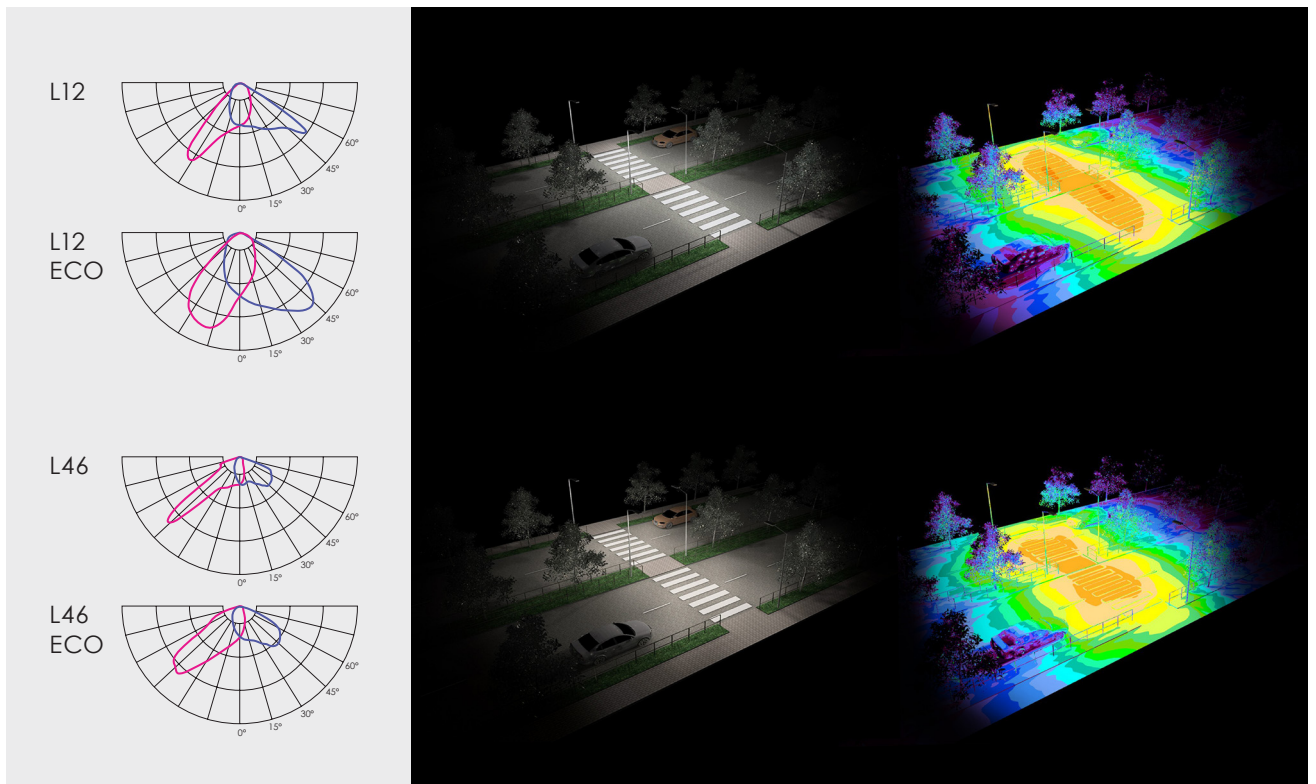

Backlight cutter

Backlight cutter | black

Art. 70000661



Backlight cutter | white

Art. 70000662



Optical losses from 10% to 31% depending from used optic.

Without backlight cutter

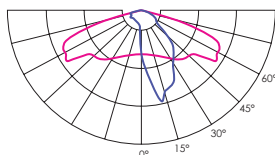

Backlight cutter | black

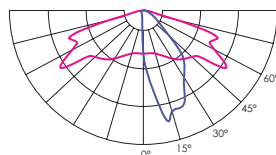

Backlight cutter | white

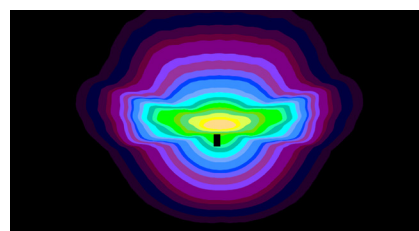
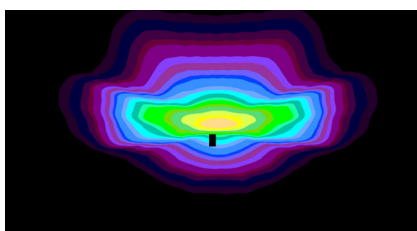
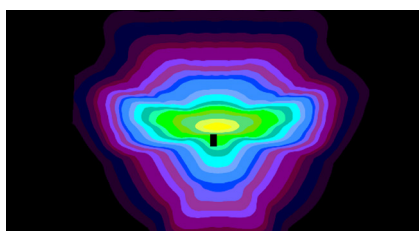
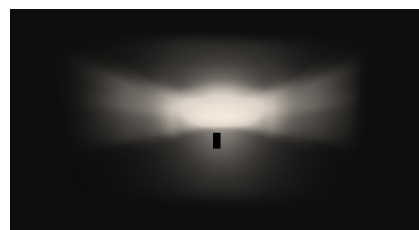
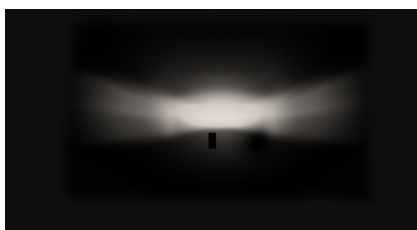
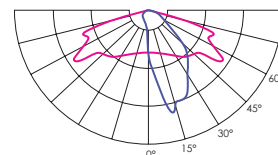

Visors



MRS back visor | silver (RAL9006)

Art. 70055120

↳ Back visor



MRS side visor | silver (RAL9006)

Art. 70055121

↳ Back + side visors



MRS front visor | silver (RAL9006)

Art. 70055122

MRS visor set | silver (RAL9006)

Art. 70055131

↳ Visor set

Accessories

MAUGLO Segment controller

Art. 70010004

Segment Controller receives commands from MAUGLO server via GSM and transmits tasks to Luminaire Controller via radio frequency communication.

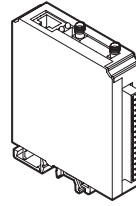

MAUGLO Luminaire controller

Art. 70010001 /
LC2M-23-05-R Luminaire
Controller - 2 relays

Luminaire Controller is wireless mesh-networking device that uses 868 MHz for communication with Segment Controller and other Luminaire Controllers. It is delivered in various configurations to meet the needs of your applications.

Art. 70010002 /
LC2M-12-05-R Luminaire
Controller - 1 relay

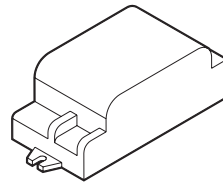

MAUGLO Surge Protection device

Art. 70020001

Surge Protection device offers protection against lighting surges;

Voltage Protection level up (L-N) $\leq 1,5$ kV

Voltage Protection level up (L/N-PE) $\leq 2,0$ kV

$U_{oc} = 10$ kV

$I_{max} = 10$ kA

$I_{nom} = 5$ kA

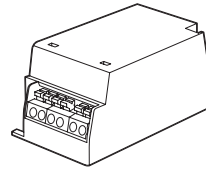

Radio Frequency Antenna

Art. 70000108

Heavy duty IP67 enclosure
Mounted in cabinet or luminaire body
with 14 mm screw
SMA connector



NEMA Socket

2213362-3, 5 pin NEMA socket 105°C wires

Art. 70000362

2213362-4, 7 pin NEMA socket 105°C wires

Art. 70000333



Dummy Link for NEMA Socket

Art. 70000113



Zhaga socket no cap

Art. 70000612

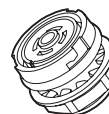

Zhaga socket with cap

Art. 70000613

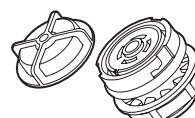

MSLC205RG Luminaire controller + radar, Zhaga, 80 mm

Art. 70010027

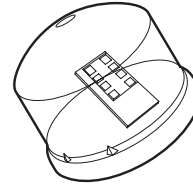

MSLC205RGL Luminaire controller, Zhaga, 80 mm

Art. 70010029

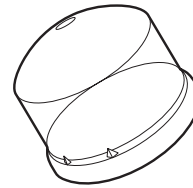

Console adapter

Spigot size 60 - 76 mm

Art. 70044002

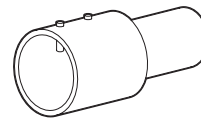

Wall mounting bracket

Spigot size 40 - 60 mm

Art. 70044001

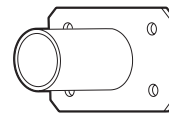

Wall mounting bracket

Vertical

Art. 70044004

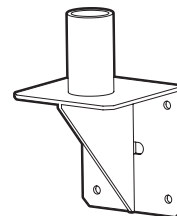

Connector

IP66 rated connector offers easy installation of the street luminaires.
3 wire cable connector

Art. 70000313

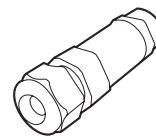

Connector

IP66 rated connector offers easy installation of the street luminaires.
5 wire cable connector

Art. 70000304

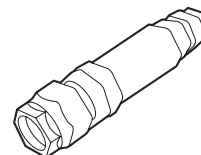

Adjustable Console ±90°

Art. 70055005

40 mm to 60 mm - Mini Martin / Micro Martin

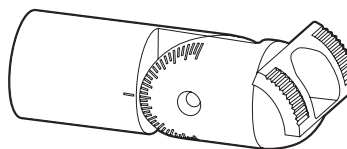

Adjustable Console ±90°

Art. 70055006

60 mm to 76 mm - Mini Martin / Micro Martin

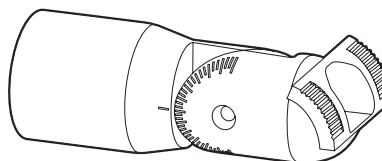

**Pre-installed cable sets
For internal power supply**

3 x 1,5 mm - 0,5 m long cable.....	Art. 70000319
3 x 1,5 mm - 5 m long cable.....	Art. 70000320
3 x 1,5 mm - 6 m long cable.....	Art. 70000321
3 x 1,5 mm - 8 m long cable.....	Art. 70000322
3 x 1,5 mm - 10 m long cable.....	Art. 70000323
3 x 1,5 mm - 12 m long cable.....	Art. 70000324
3 x 1,5 mm - 18 m long cable.....	Art. 70000325
3 x 1,5 mm - 20 m long cable.....	Art. 70000425
3 x 1,5 mm - 22 m long cable.....	Art. 70000426
3 x 1,5 mm - 25 m long cable.....	Art. 70000427
3 x 1,5 mm - 32 m long cable.....	Art. 70000430
3 x 1,5 mm - 42 m long cable.....	Art. 70000431
3 x 1,5 mm - 50 m long cable.....	Art. 70000432

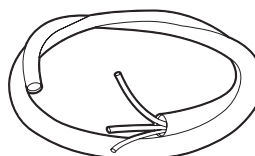

5 x 1,5 mm - 0,5 m long cable.....	Art. 70000305
5 x 1,5 mm - 5 m long cable.....	Art. 70000316
5 x 1,5 mm - 6 m long cable.....	Art. 70000317
5 x 1,5 mm - 8 m long cable.....	Art. 70000318
5 x 1,5 mm - 10 m long cable.....	Art. 70000306
5 x 1,5 mm - 12 m long cable.....	Art. 70000307
5 x 1,5 mm - 18 m long cable.....	Art. 70000308
5 x 1,5 mm - 20 m long cable.....	Art. 70000428
5 x 1,5 mm - 22 m long cable.....	Art. 70000429
5 x 1,5 mm - 25 m long cable.....	Art. 70000429
5 x 1,5 mm - 32 m long cable.....	Art. 70000433
5 x 1,5 mm - 42 m long cable.....	Art. 70000434
5 x 1,5 mm - 50 m long cable.....	Art. 70000435



Certification



CE – conformity with European Union's health, safety and environmental protection standards

The CE mark is placed on products to state conformity with the relevant EU health, safety and environmental protection standards. In case of electronic products, the standards are, for example, the Restriction of Hazardous Substances in Electrical and Electronic Equipment (RoHS) directive, Waste Electrical and Electronic Equipment (WEEE) directive, the Electromagnetic Compatibility (EMC) directive etc. The mark ensures that the product can be sold anywhere in the European Economic Area (EEA).



UKCA - conformity with the relevant essential requirements of Great Britain

UKCA is a product mark intended to demonstrate compliance with the directives set by Great Britain (England, Scotland and Wales). It is analogous to the European Union's CE marking, meaning that depending on the type of product the applicable regulations are different. In case of LED lighting, the relevant requirements are compliance with the Electromagnetic Compatibility Regulations, the Electrical Equipment (Safety) Regulations, the Restriction of the Use of Certain Hazardous Substances in Electrical and Electronic Equipment Regulations and the Ecodesign for Energy-Related Products and Energy Information (Lighting Products) Regulations.



EAC - compliance with the regulations of the Eurasian Customs Union

The EAC Mark demonstrates conformity with all technical regulations defined by the Eurasian Customs Union. The conformity is assessed by an accredited independent testing laboratory. The EAC marking is a requirement in order to place a product on the market of Russia and the Eurasian Economic Union.



RoHS – compliance with European Union's RoHS directive

The RoHS (Restriction of Hazardous Substances in Electrical and Electronic Equipment) directive restricts (with exceptions) the use of ten hazardous materials in the manufacture of various types of electronic and electrical equipment. The aim of the directive is to prevent the risks posed to human health and the environment related to the management of electronic and electrical waste.



Zhaga-D4i - compliance with the requirements of Zhaga Book 18 or 20 and DALI standard

The Zhaga-D4i Mark represents the fact that a product is certified following the Zhaga-D4i joint certification program – a program established by Zhaga and the DALI Alliance (DiiA). The Zhaga part of the Mark represents that a product meets the requirements of Zhaga Book 18 or 20 – Zhaga standards that describe a smart interface between outdoor luminaires and sensing/ communication nodes. The DALI Alliance part of the Mark signifies that the product conforms with the DALI standard for intelligent, IoT-ready luminaires.



UL - compliance with UL standards for LED lighting **[Coming soon]**

UL stands for Underwriter Laboratories, a third-party certification company that's been around for over a century. UL sets industry-wide standards for products and performs testing according to these standards to ensure that the products marked with the UL mark are safe and high quality.



ENEC - compliance with European standards for electrical equipment

The ENEC Mark is the high quality European Mark for electrical equipment. It is governed by the European Testing Inspection Certification System which ensures that the testing of products is conducted at ENEC – accredited laboratories, following additional requirements regarding the testing procedures. The ENEC Mark means that the testing procedure was followed scrupulously and that the consumer can be certain of the product's safety and quality.



ENEC+ - compliance with European standards for LED – based electronic products

The ENEC+ Mark is the high quality European Mark for LED – based electronic products. It demonstrates the product's compliance with the IEC standards for performance of LED modules and LED based luminaires. The ENEC+ Mark can only be granted to a product that has already acquired the ENEC Mark.



International EPD System – Environmental Product Declaration available

An Environmental Product Declaration (EPD) is a declaration of the materials, energy, transportation and other resources involved in the production, use and end-of life of a specific product. It is based on a Life Cycle Assessment (LCA) study that complies with standards EN ISO 14040 and EN ISO 14044. A product's EPD can help evaluate its impact on the environment and make sustainable choices.



LED module replaceable by a professional

This pictogram shows that the LED modules included in the luminaire are only replaceable by a professional. This labeling is a requirement following the introduction of European Union's Regulation on energy labelling for light sources (EU) 2019/2015.



LED driver replaceable by a professional

This pictogram shows that the LED driver included in the luminaire is only replaceable by a professional. This labeling is a requirement following the introduction of European Union's Regulation on energy labelling for light sources (EU) 2019/2015.

VIZULO

Bukultu street 11
Riga, LV – 1005, Latvia

Sales: + 371 67 383 023
Production: + 371 67 383 024

sales@vizulo.com
www.vizulo.com



VIZULO



VIZULOSOLUTIONS